

# Wood Panels



# Wood Panels

Fog & Venø wood panels are designed to create a balanced and pleasant atmosphere in your indoor spaces by enhancing both acoustics and indoor climate. These panels are made from genuine FSC®-certified wood veneer, which not only ensures a natural and elegant appearance but also guarantees that the wood comes from responsibly managed forests. With a focus on responsibility throughout the production process, Fog & Venø wood panels are the conscious choice for the environmentally aware consumer.

With their clean and modern Danish design, the panels combine aesthetics with functionality, adding a stylish finish to any room. With the various options available, you can choose the exact panel that meets your design preferences.

## With our wood panels, you get:

### Creative Freedom

Wood panels offer you endless possibilities to create your own unique expression and design.

### Exclusive Design

An exclusive appearance, produced with a focus on aesthetics and elegance.

### Danish Craftsmanship

Produced in Central Jutland, ensuring a high standard of quality through Danish design and production.

### The Responsible Choice

After their lifespan, the panels can be recycled, highlighting our commitment to responsible design and environmental awareness.

## Features:

- **Local production**  
All panels are produced in Denmark.
- **Attractive square meter price**  
Competitive price per square meter.
- **Quick assembly**  
Easy and quick installation.
- **Minimal use of tools**  
Requires only a few tools for installation and adjustment.
- **Lightweight construction**  
The panels have a low weight, which simplifies handling.
- **Varied surface options**  
Options for different veneer surfaces and core colors.
- **Veneer oiling**  
Optional purchase of care oils for maintenance and toning of the surface veneer.
- **Environmentally certified materials**  
FSC®-certified MDF and veneer, and CARB2-approved MDF.
- **Cleaning**  
Our panels can easily be cleaned with a wrung-out damp cloth.



These panels are made from FSC™ certified wood and veneer and other controlled materials.  
FSC™ C165957



Wood panels with a black core are certified with the Nordic Swan Ecolabel.







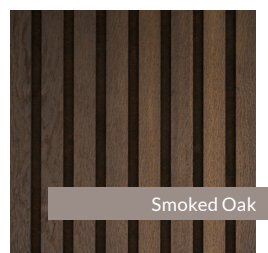
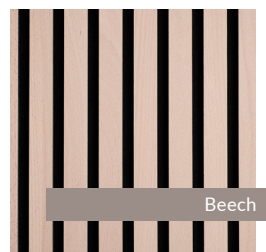



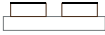





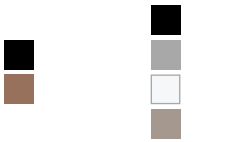

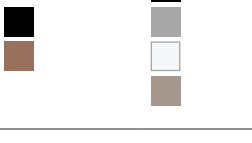

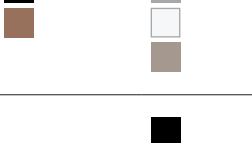

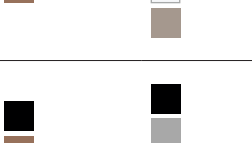

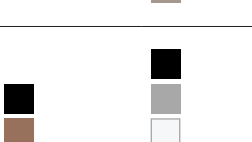
Sorted as recycled wood.

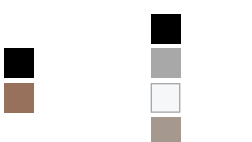

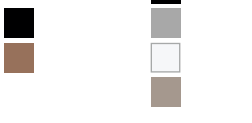

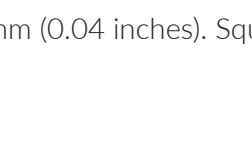
# Specifications

 Veneer	 Core	 Felt	 Dimensions	 m <sup>2</sup> - f <sup>2</sup>	 Weight
American Walnut			1200 x 600 x 20 mm - 47.24 x 23.62 x 0.79 in	0,72 - 7.75	4,9 kg
			2400 x 600 x 20 mm - 94.49 x 23.62 x 0.79 in	1,44 - 15.50	9,7 kg
			2700 x 600 x 20 mm - 106.30 x 23.62 x 0.79 in	1,62 - 17.44	10,9 kg
			3000 x 600 x 20 mm - 118.11 x 23.62 x 0.79 in	1,80 - 19.38	12,1 kg
			3600 x 600 x 20 mm - 141.73 x 23.62 x 0.79 in	2,16 - 23.25	14,6 kg
Ash			1200 x 600 x 20 mm - 47.24 x 23.62 x 0.79 in	0,72 - 7.75	4,9 kg
			2400 x 600 x 20 mm - 94.49 x 23.62 x 0.79 in	1,44 - 15.50	9,7 kg
			2700 x 600 x 20 mm - 106.30 x 23.62 x 0.79 in	1,62 - 17.44	10,9 kg
			3000 x 600 x 20 mm - 118.11 x 23.62 x 0.79 in	1,80 - 19.38	12,1 kg
			3600 x 600 x 20 mm - 141.73 x 23.62 x 0.79 in	2,16 - 23.25	14,6 kg
Beech			1200 x 600 x 20 mm - 47.24 x 23.62 x 0.79 in	0,72 - 7.75	4,9 kg
			2400 x 600 x 20 mm - 94.49 x 23.62 x 0.79 in	1,44 - 15.50	9,7 kg
			2700 x 600 x 20 mm - 106.30 x 23.62 x 0.79 in	1,62 - 17.44	10,9 kg
			3000 x 600 x 20 mm - 118.11 x 23.62 x 0.79 in	1,80 - 19.38	12,1 kg
Mahogany			1200 x 600 x 20 mm - 47.24 x 23.62 x 0.79 in	0,72 - 7.75	4,9 kg
			2400 x 600 x 20 mm - 94.49 x 23.62 x 0.79 in	1,44 - 15.50	9,7 kg
			2700 x 600 x 20 mm - 106.30 x 23.62 x 0.79 in	1,62 - 17.44	10,9 kg
			3000 x 600 x 20 mm - 118.11 x 23.62 x 0.79 in	1,80 - 19.38	12,1 kg
Oak			1200 x 600 x 20 mm - 47.24 x 23.62 x 0.79 in	0,72 - 7.75	4,9 kg
			2400 x 600 x 20 mm - 94.49 x 23.62 x 0.79 in	1,44 - 15.50	9,7 kg
			2700 x 600 x 20 mm - 106.30 x 23.62 x 0.79 in	1,62 - 17.44	10,9 kg
			3000 x 600 x 20 mm - 118.11 x 23.62 x 0.79 in	1,80 - 19.38	12,1 kg
			3600 x 600 x 20 mm - 141.73 x 23.62 x 0.79 in	2,16 - 23.25	14,6 kg
Smoked Oak			1200 x 600 x 20 mm - 47.24 x 23.62 x 0.79 in	0,72 - 7.75	4,9 kg
			2400 x 600 x 20 mm - 94.49 x 23.62 x 0.79 in	1,44 - 15.50	9,7 kg
			2700 x 600 x 20 mm - 106.30 x 23.62 x 0.79 in	1,62 - 17.44	10,9 kg
			3000 x 600 x 20 mm - 118.11 x 23.62 x 0.79 in	1,80 - 19.38	12,1 kg
Rustic Oak			1200 x 600 x 20 mm - 47.24 x 23.62 x 0.79 in	0,72 - 7.75	4,9 kg
			2400 x 600 x 20 mm - 94.49 x 23.62 x 0.79 in	1,44 - 15.50	9,7 kg
			2700 x 600 x 20 mm - 106.30 x 23.62 x 0.79 in	1,62 - 17.44	10,9 kg
			3000 x 600 x 20 mm - 118.11 x 23.62 x 0.79 in	1,80 - 19.38	12,1 kg
Grey Rustic Oak			1200 x 600 x 20 mm - 47.24 x 23.62 x 0.79 in	0,72 - 7.75	4,9 kg
			2400 x 600 x 20 mm - 94.49 x 23.62 x 0.79 in	1,44 - 15.50	9,7 kg
			2700 x 600 x 20 mm - 106.30 x 23.62 x 0.79 in	1,62 - 17.44	10,9 kg
			3000 x 600 x 20 mm - 118.11 x 23.62 x 0.79 in	1,80 - 19.38	12,1 kg

## Tolerances

Tolerances: +/- 1mm (0.04 inches). Squareness: Length/width +/- 1mm (0.04 inches). Weight +/- 10%

# Wood Panels

(+/- 1mm)  
600 x 3600 mm  
(+/- 0.04in)  
23.62 x 141.73 in

(+/- 1mm)  
600 x 3000 mm  
(+/- 0.04in)  
23.62 x 118.11 in

(+/- 1mm)  
600 x 2700 mm  
(+/- 0.04in)  
23.62 x 106.30 in

(+/- 1mm)  
600 x 2400 mm  
(+/- 0.04in)  
23.62 x 94.49 in

(+/- 1mm)  
600 x 1200 mm  
(+/- 0.04in)  
23.62 x 47.24 in

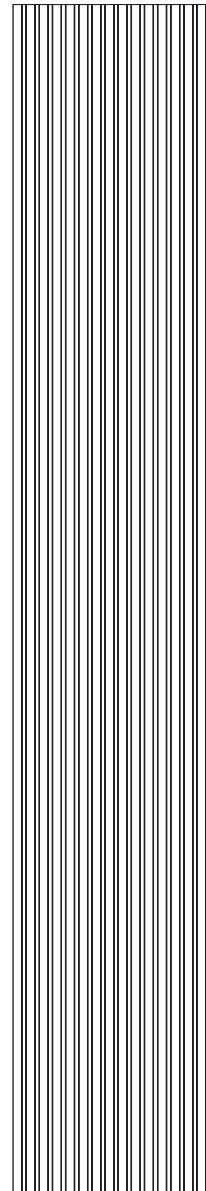
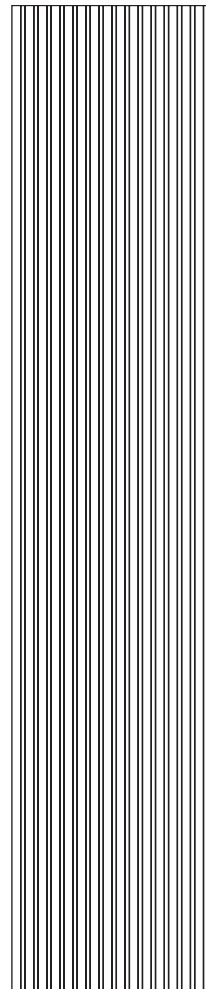
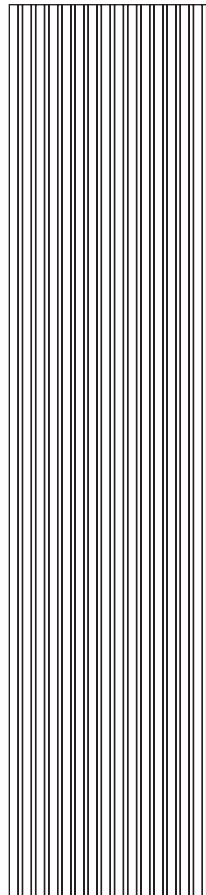
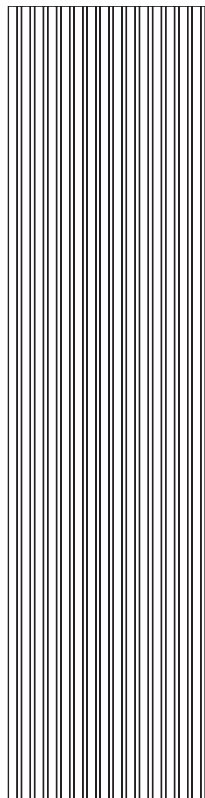
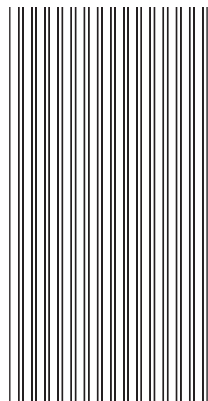

0,5 mm  
0.02 in

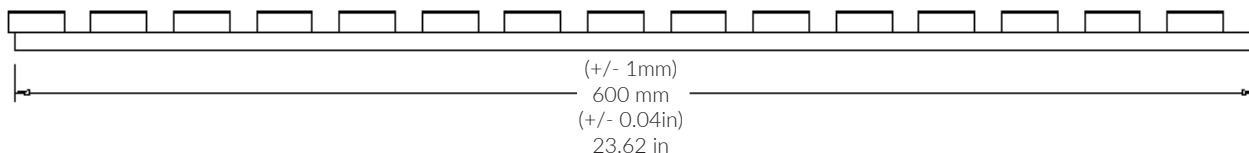
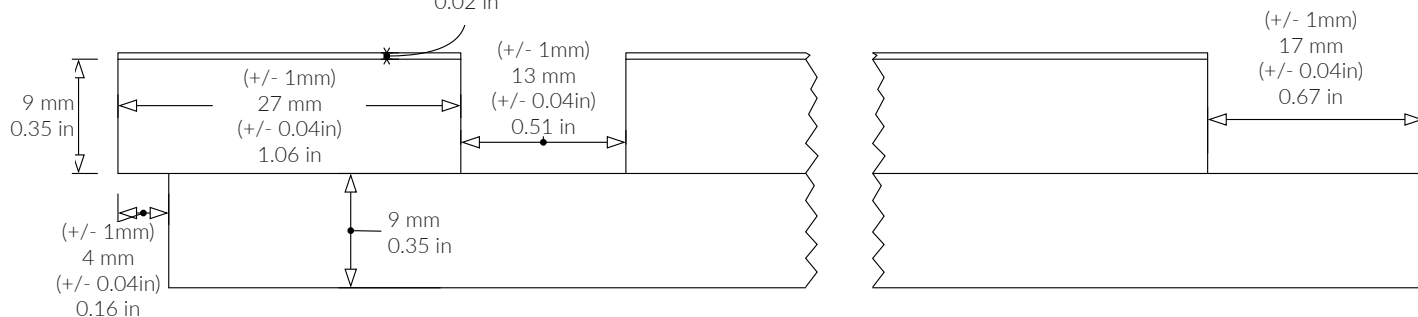

# Acoustic Measurements

Sound test according to DS/EN ISO 354:2003

## Sound test with 45mm air behind the panel

Test area: 10,8 m<sup>2</sup>  
 Room volume: 215 m<sup>3</sup>  
 Room surface area: 305 m<sup>2</sup>

Frequency [Hz]	$\alpha_s$
100	0.09
125	0.22
160	0.30
200	0.53
250	0.56
315	0.87
400	0.99
500	0.97
630	0.97
800	1.02
1k	1.02
1.25k	0.91
1.6k	0.90
2k	0.87
2.5k	0.80
3.15k	0.81
4k	0.77
5k	0.71

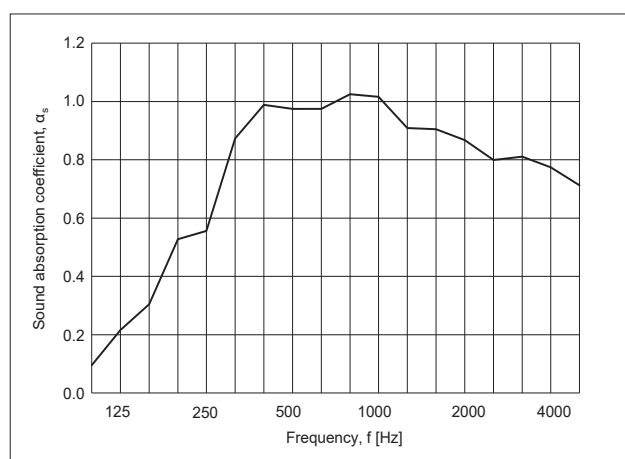

Figure 1: Sound test mounted with 45mm air behind the panel. Closed frame around the edge.

## Sound test with direct wall mounting

Test area: 10,8 m<sup>2</sup>  
 Room volume: 215 m<sup>3</sup>  
 Room surface area: 305 m<sup>2</sup>

Frequency [Hz]	$\alpha_s$
100	0.02
125	0.02
160	0.02
200	0.05
250	0.05
315	0.11
400	0.16
500	0.26
630	0.32
800	0.46
1k	0.63
1.25k	0.78
1.6k	0.97
2k	1.11
2.5k	1.05
3.15k	0.88
4k	0.75
5k	0.68

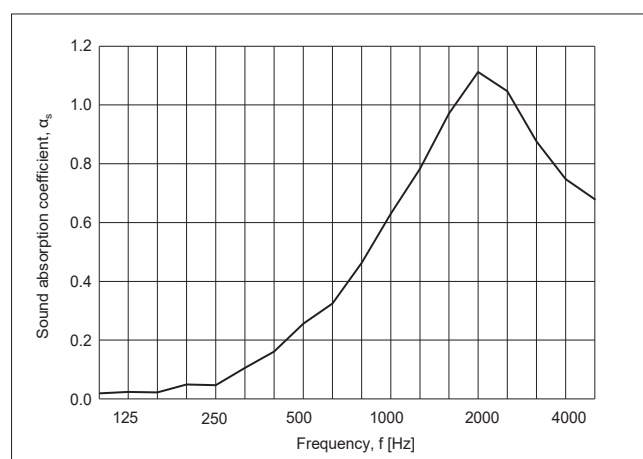
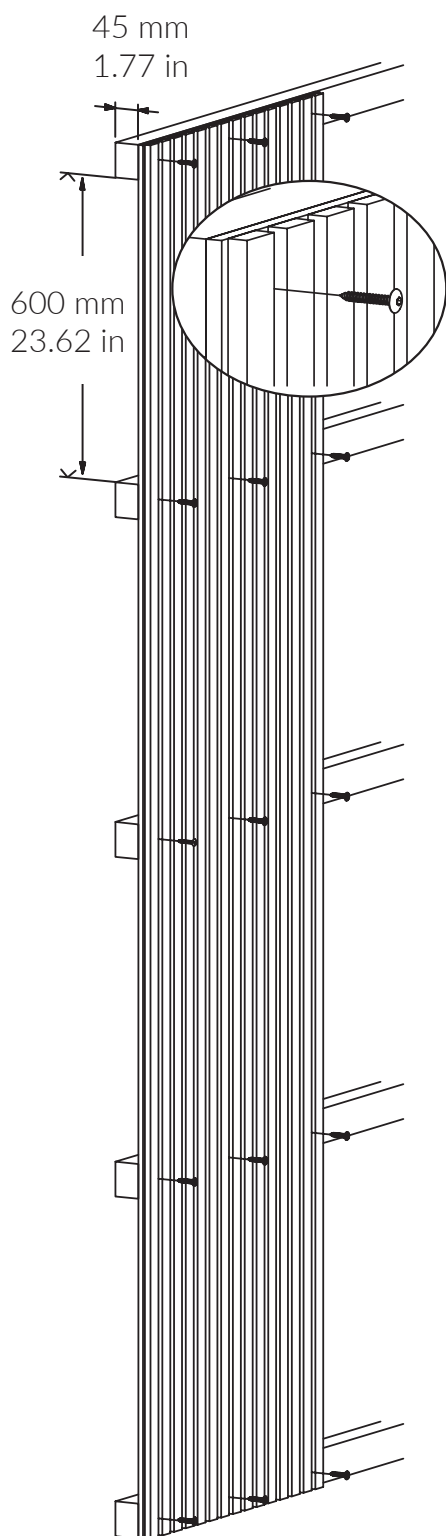

Figure 2: The sound test shows direct wall mounting.

### Tests:

Formaldehyde test: Danish Technological Institute  
 Indoor climate test: Danish Technological Institute  
 Acoustic test: Danish Technological Institute

# Installation Guide



## Method 1

### - Directly on the wall

**Mounting adhesive:** Apply the adhesive to the panel and place it against the wall. Ensure it is firmly pressed.

**Screws:** Screw the panel through the felt and into the wall. We recommend using 4 screws per panel. Remember to use wall plugs if your wall type requires it.

## Method 2

### - On a batten

For optimal sound absorption, set up a batten with 45 mm (1.77 in) battens on your wall. We recommend a spacing of 600 mm (23.62 in) between your battens. Insert mineral wool between the battens. Screw the panel onto the battens through the felt.

#### Panel adaptation:

If you need to customize the panels in width or length, we recommend using a plunge saw or circular saw for cutting.

#### Alternative mounting:

Nail gun diving

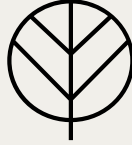

# FOG & VENØ A/S

Fog & Venø is a leading Danish manufacturer of acoustic and decorative panels with and without acoustic properties. These products are designed and manufactured with a focus on Danish craftsmanship and a constant pursuit of high quality.

The panels are suitable for installation on both walls and ceilings.

Fog & Venø has a strategic partnership with world-leading suppliers of materials such as wood veneer, linoleum, foil, and laminate, ensuring that all Fog & Venø products maintain a high standard and a wide range of options. This means that there is constantly reverberation in the room, and this is where our acoustic panels make a big difference.

Our Danish-produced acoustic panels break the sound and absorb the sound wave, so it dies out when it hits the panels. This means that the sound wave is eliminated and the reverberation time is shortened, which will improve the indoor climate and the feeling of well-being in the room, whether it is private, commercial, or public buildings we are talking about.

## Kontaktinformation

Fog & Venø A/S  
Buntmagervej 5, DK-7490 Aulum  
Tel: (+45) 88 77 83 70  
hello@fog-veno.com  
[www.fog-veno.com](http://www.fog-veno.com)